



LIGHT-CURABLE MATERIALS FOR AUTOMOTIVE ELECTRONICS



Only Dymax offers expert knowledge of light-cure technology, along with a full array of light-cure products. Dymax is committed to developing a true collaborative partnership — applying our extensive process knowledge to your specific application challenges.

We create custom solutions to ensure that chemistry and equipment work seamlessly together with maximum efficiency. Our application engineering team works side-by-side with our customers, providing assistance with formulation, testing, evaluation, and pre-production trials. We also offer an extensive inventory of curing equipment, manual and automated dispensing systems to help you achieve a more efficient, cost-effective manufacturing process.

About Dymax

Dymax Corporation is an ISO 9001 registered leading manufacturer of light-curable adhesives, coatings, maskants, oligomers, light-curing equipment, and fluid dispense systems that work together to optimize assembly processes. Dymax products provide design, research, and manufacturing engineers value-added tools to dramatically improve manufacturing efficiency and lower costs.

The company's first products, a patented line of structural adhesives that combined high bond strength with fast fixture speed, offered significant productivity improvement to manufacturers of electric motors and were widely used in OEM and manufacturing environments. Dymax continued to create formulations that offered faster processing speeds for a large segment of the industrial market. This eventually led to the development of light-cure adhesive technology and the compatible fluid dispensing and light-curing systems needed to dispense and cure the products.

Today, Dymax light-curable materials cure in seconds upon exposure to UV/Visible light, form high-strength, environmentally resistant bonds to glass, metal, and plastic substrates, and are ideal for bonding dissimilar materials. Formulations with activators and secondary heat or moisture cure are also available. Dymax supplies these products to the automotive, aerospace, appliance, alternative energy, electronic, industrial, medical device, and optical industries worldwide.

Since pioneering light-cure technology over 40 years ago, Dymax has continued to develop innovative ways to co-optimize the assembly process with customer-centric solutions that meet today's application challenges. Dymax owns over 30 patents and has a worldwide network of technical experts who understand manufacturers' demands and assist them with adhesive selection, dispensing options, curing recommendations, component design, and process validation. The result of this collaboration is faster, more reliable processing, less energy consumption, and lower production costs.

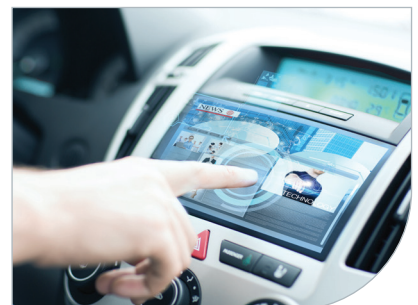
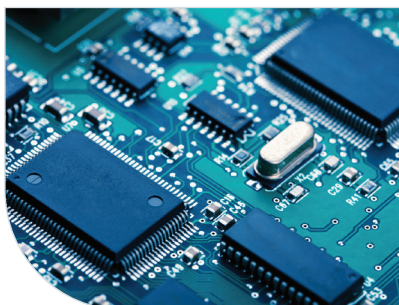

Light-Curable Materials

From adhesives to conformal coatings and encapsulants, Dymax provides innovative, solvent-free, UV light-curing technology solutions for the automotive electronics industry. We offer many cost-reducing solutions that turn problems like shadow areas, cure confirmation, and production throughput into non-issues. Many of our electronic assembly materials display excellent performance when exposed to corrosive elements like sulfur, moisture, and salt, which vehicles are typically exposed to. IPC approved, MIL-I-46058C and UL listed self-extinguishing grades are also available.

Dymax Asia Pacific Pte Ltd's Quality Management System conforms to IATF 16949:2016 requirements.

Adhesives

Dymax light-curable adhesives cure in seconds upon exposure to ultraviolet light and/or visible light, heat, or activator. Our adhesives are solvent free and form high-strength, environmentally-resistant bonds to plastic, metal, and glass substrates. Because of their ability to bond to a wide variety of substrates, they excel at assembling dissimilar materials, something that cannot be done with traditional welding methods and other types of adhesives.

Conformal Coatings

Dymax manufactures UV/Visible light curing conformal coatings to protect printed circuit boards. The conformal coating is applied to electronic circuitry to act as protection against moisture, dust, chemicals, and temperature extremes that if uncoated (unprotected) could result in a complete failure of the electronic system. Dymax conformal coatings are available in IPC approved, MIL-I-46058C, and UL listed self-extinguishing grades.

Encapsulants

Dymax encapsulants cure in seconds upon exposure to UV and/or visible light to provide tough, flexible protection for bare die, wire bonds, or integrated circuits (IC). The encapsulants' fast cure helps reduce processing and energy costs associated with alternative technologies. The materials are all one part, so no mixing is required and viscosity is consistent.

Form-In-Place Gaskets

Light-curable form in place gaskets replace tape, PSA die-cut gaskets, 2K epoxies, silicone rope, and RTV sealants. The gaskets conform to complex and intricate channels, on both vertical and horizontal surfaces, with thixotropic formulations, and flow into channels with Newtonian formulations. Form in place gasket materials act as a barrier to prevent absorption or penetration of air, dust, noise, liquids, gaseous substances, or dirt for sound dampening, vibration dampening, moisture protection, chemical protection, and air sealing.

Potting Materials

Dymax potting materials cure tack free in seconds upon exposure to UV/Visible light. Each potting compound is engineered to bond different substrates, offering tenacious adhesion to plastics and metals. UV potting resins reduce waste from off-ratio mixing and are free from isocyanates and heavy metals. Processing in seconds eliminates fixtures, jigs, racks, and ovens to increase space and lower total inventory costs.

SpeedMask® Maskants

SpeedMask® peelable electronic masks are solvent-free, 100% solids resins designed for the masking of printed circuit board components prior to conformal coating application or wave solder and reflow processes. They cure in seconds "on-demand" when exposed to UV/Visible light. The fast cure allows boards to be immediately processed without the need for racking or waiting. The masks have low odor and require no special venting. The cured materials also leave no silicone, ionic contamination, or corrosive residues.

Our Commitment to Greener, Safer Manufacturing

Dymax is committed to green manufacturing that reduces environmental impact, conserves energy, and provides greater worker safety. Over the last 40 years, our light-curable materials and curing equipment have become the industry standard for fast, environmentally conscious assembly. Dymax products are readily replacing technologies that contain hazardous ingredients, produce waste, or require higher amounts of energy to process.

Dymax Halogen-Free conformal coatings, encapsulants, and adhesives are documented by an independent laboratory to meet or exceed standards set forth in IEC 61249-2-21. This international directive defines halogen-free as <900 ppm for chlorine, <900 ppm for bromine and <1,500 ppm total level of both combined. The current test method used for certification is BS EN 14582:2007.



Eco-friendly, one-component materials



Materials without solvents, halogens, and other materials of concern for improved worker and user safety



Fast curing products and equipment designed for less energy consumption



Dymax products conform to regulatory standards like RoHS and REACH

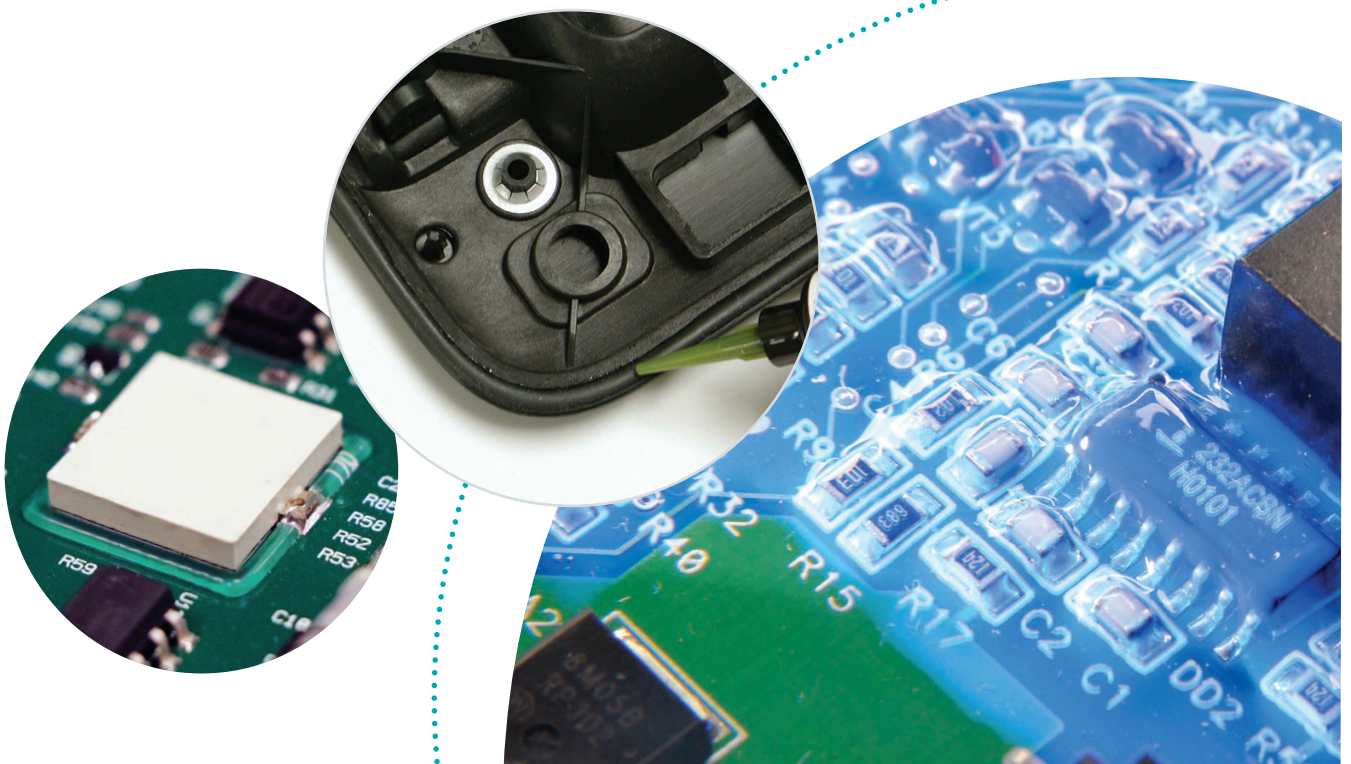

Typical Applications



Conformal Coatings

- 1 - Electronic Throttle Control
- 2 - Control Modules and Sensors
- 3 - Battery Management Systems (Hybrid and Electric Vehicles)
- 4 - Drive Shaft Coatings
- 5 - Door and Window Controls
- 6 - EGR Valve
- 7 - Tire Pressure Indicators
- 8 - Navigation System

9 - Airbag Sensors

10 - Power Steering Module

11 - Instrument Panel Circuitry

12 - Audio Circuitry

13 - Heating and Cooling Circuitry

Encapsulants

14 - Wire Coating

Potting Materials

15 - Lighting/Active Alignment

16 - Battery Pack Potting (Hybrid & Electric Vehicles)

17 - Wire Harness

18 - Module Damming

Materials for Camera Assembly

19 - Rear View Camera

20 - Front View Camera

21 - Camera Modules (ADAS)

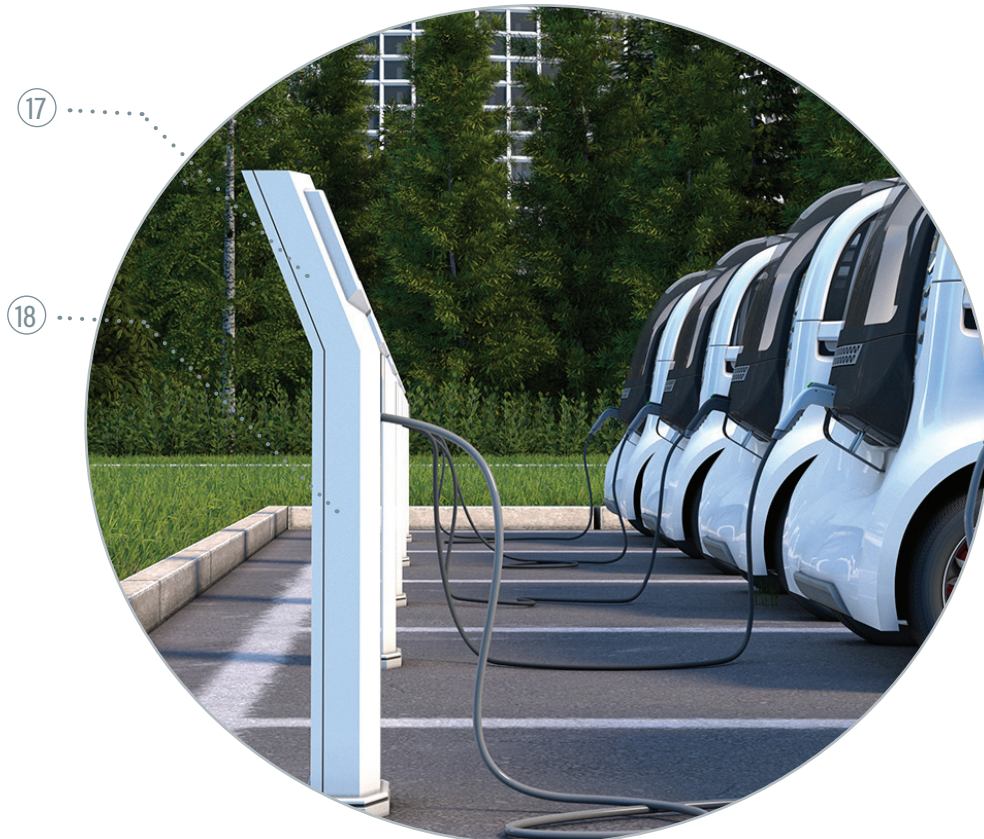

Available Products

Product Name	UV/Visible Light	Heat	Moisture	Features/ Applications	Nominal Viscosity, cP	Durometer Hardness	Tensile at Break, MPa [psi]	Modulus of Elasticity, MPa [psi]
CONFORMAL COATINGS								
9-20557	•	•		Flexible; medium-viscosity coating for thin coating applications; solvent free; isocyanate free; blue fluorescing	2,300	D60	15.8 [2,300]	37.9 [5,500]
9483	•		•	Excellent chemical and thermal shock resistance; flame retardant; bright blue fluorescing; great temperature/humidity performance; approvals: MIL-I-46058C, IPC-CC-830-B, UL 746E, UL 94V-0, Hyundai MS941-04	750	D60	16.2 [2,350]	276 [40,000]
9-20557-LV	•	•		Flexible for enhanced thermal shock performance; blue fluorescing; approvals: MIL-I-46058C, IPC-CC-830-B	850	D70	21.7 [3,150]	310 [45,000]
9481-E	•		•	Dual-cure for shadow areas; solvent free; blue fluorescing	125	D75	11 [1,600]	150 [21,800]
9482	•		•	Blue fluorescing; flexible; thermal shock resistance; superior re-workability; approvals: MIL-I-46058C, IPC-CC-830-B, UL 746E, UL 94V-0	1,100	D70	15.8 [2,300]	275 [40,000]
ENCAPSULANTS FOR PRINTED CIRCUIT BOARDS AND WIRE COATING								
9014	•		•	Flexible; cures with UV light but includes a secondary moisture cure function for shadow areas	12,500	A70	8.2 [1,200]	119 [17,300]
9037-F	•	•		Flexible; good moisture and thermal resistance; blue fluorescing	55,000	D40	5.8 [850]	6.2 [900]
9-20558-REV-A	•	•		High viscosity; thixotropic for minimal movement after dispense; flexible; bonds well to FPCs; UL 94V-0 certified	24,000	D35	6.2 [900]	2.3 [340]
9001-E-V3.1	•	•		High viscosity; excellent adhesion to PCB & components	4,500	D45	5.2 [750]	17 [2,500]
9008	•			Flexible; excellent adhesion to polyimide	4,500	D35	10 [1,500]	45 [6,500]
9101	•		•	Dual-cure for shadow areas; flexible; moisture and thermal resistance	7,000	D30-D50	5.06 [735]	175 [2,550]
9102	•	•	17,000		D30-D50	4.8 [703]	18.4 [2,670]	
9103	•	•	25,000		D30-D50	4.9 [718]	176 [2,560]	

 Featured Product

Product Name	UV/Visible Light	Heat	Moisture	Features/ Applications	Nominal Viscosity, cP	Durometer Hardness	Tensile at Break, MPa [psi]	Modulus of Elasticity, MPa [psi]
FORM-IN-PLACE / CURE-IN PLACE GASKETS								
GA-140	•			Low outgassing; excellent teat resistance; cures soft and tack free; conforms to intricate channels and recesses; silicone free	39,000	A35	1.5 [211]	0.71 [104]
GA-201	•			Tack-free after proper cure; moisture and chemical resistant; soft and durable; conforms to intricate channels	65,000	A35	0.93 [135]	0.75 [110]
MATERIALS FOR ADVANCED DRIVER ASSISTANCE SYSTEMS (ADAS)								
9801	•	•		Ideal for active alignment (camera module holder to board bonding); low shrinkage; one-part epoxy; low temperature heat cure (80-85°C); good moisture and thermal resistance; cold storage/ship; flexible	60,000	D90	45 [6,600]	1,600 [230,600]
9803	•	•		Ideal for active alignment; very low volumetric shrinkage and water absorption; one-part epoxy; low temperature heat cure (80-85°C); moisture and thermal cycle resistant; cold storage/ship	86,000	D94	36.7 [5,328]	3,983 [578,000]
3094-GEL-REV-A	•			Fast curing; low shrinkage and stress	30,000	D67	12.4 [1,800]	179 [26,000]
MATERIALS FOR EV BATTERY PACK ASSEMBLY								
6-621-VT	•	•		For structural bonding applications; forms hard, clear bonds to a wide variety of substrates including plastic, metal, and glass; activator cure	14,000	D80	28 [4,000]	730 [106,000]
9501-F	•			For structural bonding applications; excellent adhesion to metals and plastics; blue fluorescing; LED curable at 385 nm	10,000	D65	17.2 [2,500]	545 [79,000]
POTTING MATERIALS								
9-20557	•	•		Low modulus for enhanced thermal cycling performance; blue fluorescing; isocyanate free; one part - no mixing or dilution required	2,300	D60	15.8 [2,300]	37.9 [5,500]
9001-E-V3.1	•	•		Excellent adhesion to engineering plastics; flexible; excellent moisture and thermal cycle resistance; clear	4,500	D45	5 [750]	17 [2,500]
9008	•			Remains flexible at low temperatures; highly moisture resistant	4,500	D35	10 [1,500]	45 [6,500]

Featured Product

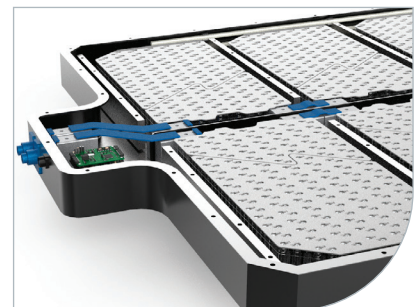
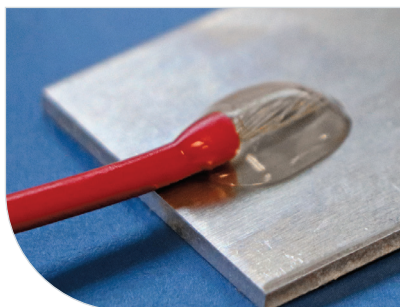
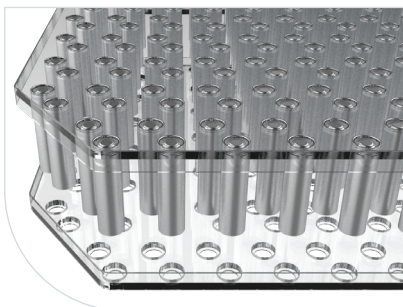

Product Name	UV/Visible Light	Heat	Moisture	Features/ Applications	Nominal Viscosity, cP	Durometer Hardness	Tensile at Break, MPa [psi]	Modulus of Elasticity, MPa [psi]
RUGGEDIZING/EDGE BOND MATERIALS FOR BGAS & VGAS								
9309-SC	•			Formulated with See-Cure technology; highly thixotropic	45,000	D57	22 [3,200]	163 [23,800]
SPEEDMASK® MASKANTS								
9-7001	•			Pink color when uncured; resistant to solvent-based conformal coatings and primers; compatible with gold and copper connector pins	40,000	A70	3.8 [560]	1.9 [275]
9-20479-B-REV-A	•			Blue in color for easy visual inspection; compatible with gold and copper connector pins; thixotropic for manual or automated dispensing	115,000	A75	3.37 [490]	4.13 [600]
9-318-F	•			Highly thixotropic for manual or automated dispensing; very low VOCs; blue fluorescing	50,000	A55	3 [440]	2 [310]

■ Featured Product

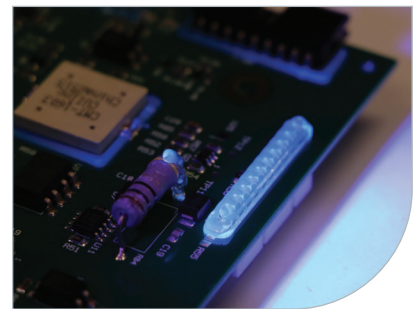
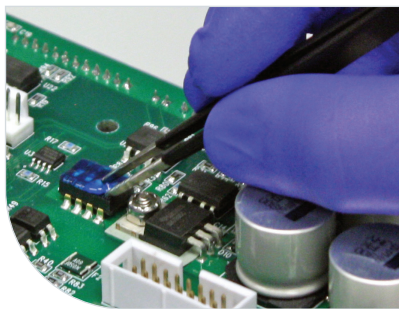
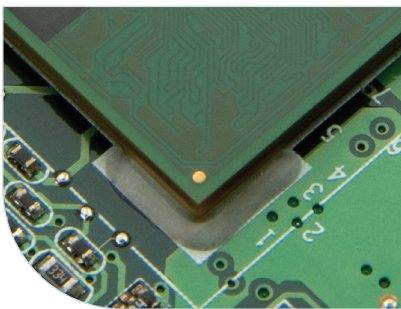

Chemical Resistance Study

Dymax Conformal Coatings Against Automotive Fluids

A selection of Dymax conformal coatings were tested for their chemical resistance against a variety of fluids commonly found in the automotive industry. The conformal coatings were dispensed and then cured for 20 seconds using a Dymax 5000-EC flood lamp at an intensity of 200 mW/cm². The samples were then immersed in the fluids for 72 hours, after which they were removed and wiped clean. The samples were then left at room temperature for 1 week. The initial weights of the sample coatings were recorded, as well as the weights after the 72 hour soak and after the 1 week.

Product			Motor Oil	Brake Fluid	Transmission Oil	Power Steering Fluid	Water 5% NaCl	IPA 99%	Diesel Fuel
9-20557	Initial Weight (grams)		0.71	0.70	0.67	0.68	0.69	0.72	0.69
	Change from Initial Weight	72 Hours	0.24%	64.59%	0.88%	0.13%	3.02%	64.45%	9.02%
		1 Week	0.06%	60.29%	0.49%	-0.13%	-0.41%	2.49%	4.28%
9483	Initial Weight (grams)		0.75	0.76	0.78	0.78	0.78	0.78	0.80
	Change from Initial Weight	72 Hours	-0.90%	7.47%	0.00%	0.00%	0.44%	18.73%	0.42%
		1 Week	-1.33%	4.84%	0.00%	-0.44%	-0.43%	3.00%	0.42%
9481-E	Initial Weight (grams)		0.71	0.72	0.70	0.70	0.70	0.07	0.71
	Change from Initial Weight	72 Hours	0.05%	1.00%	-0.04%	0.13%	0.66%	7.51%	0.07%
		1 Week	0.06%	0.45%	0.01%	0.04%	0.01%	5.08%	-0.03%
9482	Initial Weight (grams)		0.72	0.71	0.71	0.72	0.72	0.71	0.72
	Change from Initial Weight	72 Hours	0.02%	5.15%	-0.05%	-0.01%	0.73%	15.62%	0.49%
		1 Week	0.02%	3.74%	0.01%	-0.07%	-0.03%	5.35%	0.07%

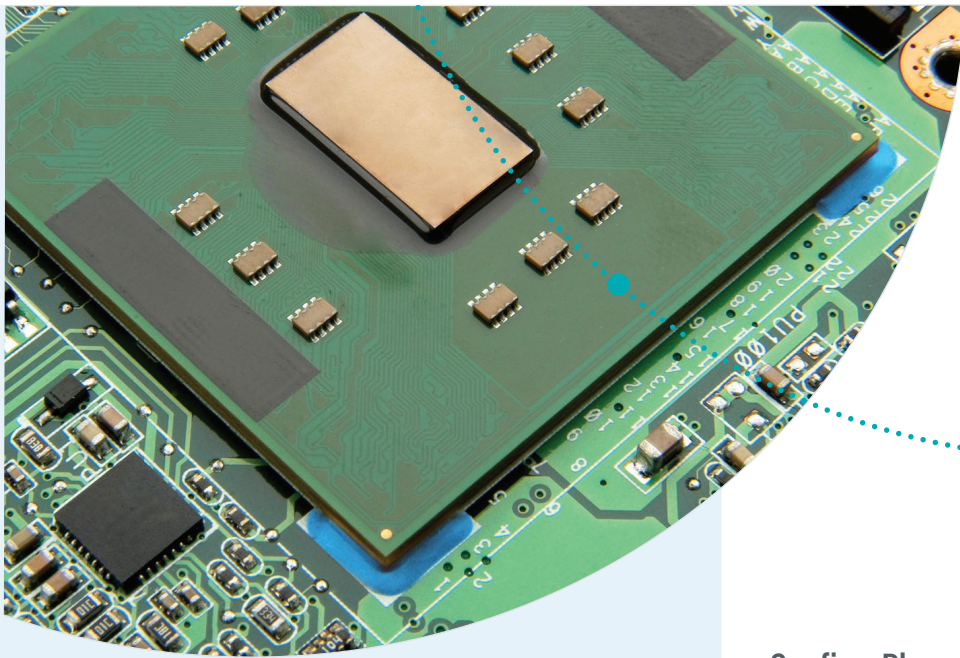

Innovative Technologies

As an innovator in the adhesive and coating industries, Dymax strives to create new technologies that help manufacturers increase process efficiency, productivity, and throughput while decreasing costs and inventory. Through the years, our dedication to innovation has resulted in over 30 oligomer, adhesive, and equipment patents and numerous awards for our innovative technologies and service.

Our R&D experts are always striving to create new technologies that will help manufacturers improve their processes. Our current portfolio of technologies provide a variety of benefits including easier bond line inspection and cure confirmation for better quality control, faster cures for quicker processing, and curing in shadowed areas to eliminate concerns about uncured material.

Confirm Placement & Cure - Patented See-Cure Technology

Dymax adhesives formulated with See-Cure technology have built-in cure validation that makes it easy for operators or simple automated inspection equipment to confirm cure without investing in additional specialized equipment. These materials are bright blue in their uncured state, making them highly visible when dispensed onto substrates. Workers can easily confirm the adhesive placement and quantity with just their eyes.

After the adhesive is exposed to light, the color transitions from blue to colorless. This cure indicator ensures the adhesive is completely cured, providing a critical safety feature for manufacturing processes.

Speed up Production with Faster Cures - LED Light-Curing Technology

Dymax offers specially formulated LED light-curable adhesives that are optimized to work seamlessly with Dymax LED light-curing systems. The adhesives range from fast to ultra-fast cure speeds in order to accommodate specific assembly needs. LED-curing equipment is available in a number of different styles including spot lamps, flood lamps, and conveyors to accommodate various process requirements.

Enhance Bond-Line Inspection - Ultra-Red® Technology

Adhesives formulated with Ultra-Red® remain colorless until exposed to low-intensity UV light (360-380 nm), at which point they fluoresce bright red. This is ideal when bonding plastics that naturally fluoresce blue. Ultra-Red® fluorescence does not absorb the same wavelengths as those used to cure the adhesive, resulting in faster, deeper cures when compared to blue fluorescing products.

The Ultra-Red® fluorescing compound is patented and exclusive to Dymax. When measured, this compound produces a unique energy peak that cannot be reproduced by other fluorescing compounds. This offers manufacturers the ability to assemble or mark their products so they can be positively identified.

Cure in Shadows - Multi-Cure® Light/Heat Cure Technology

Multi-Cure adhesives and coatings combine the high-speed cure of UV or UV/Visible light with secondary cure mechanisms that enhance polymerization. Secondary cure mechanisms, which include moisture, thermal, or activator cure, are useful when light can only reach a portion of the bond line, or when tacking a part prior to final cure to allow easier handling and transport during the manufacturing process.

Cure in Shadows - Dual-Cure Light/Moisture-Cure Technology

Dual-cure coatings are formulated to ensure complete cure in applications where shadow areas on high-density circuit boards are a concern. Previously, areas shadowed from light were managed by selective coating – eliminating the need to cure in shadow areas – or a secondary heat-cure process. Shadow areas cure over time with moisture, eliminating the need for that second process step or concerns of component life degradation due to temperature exposure.

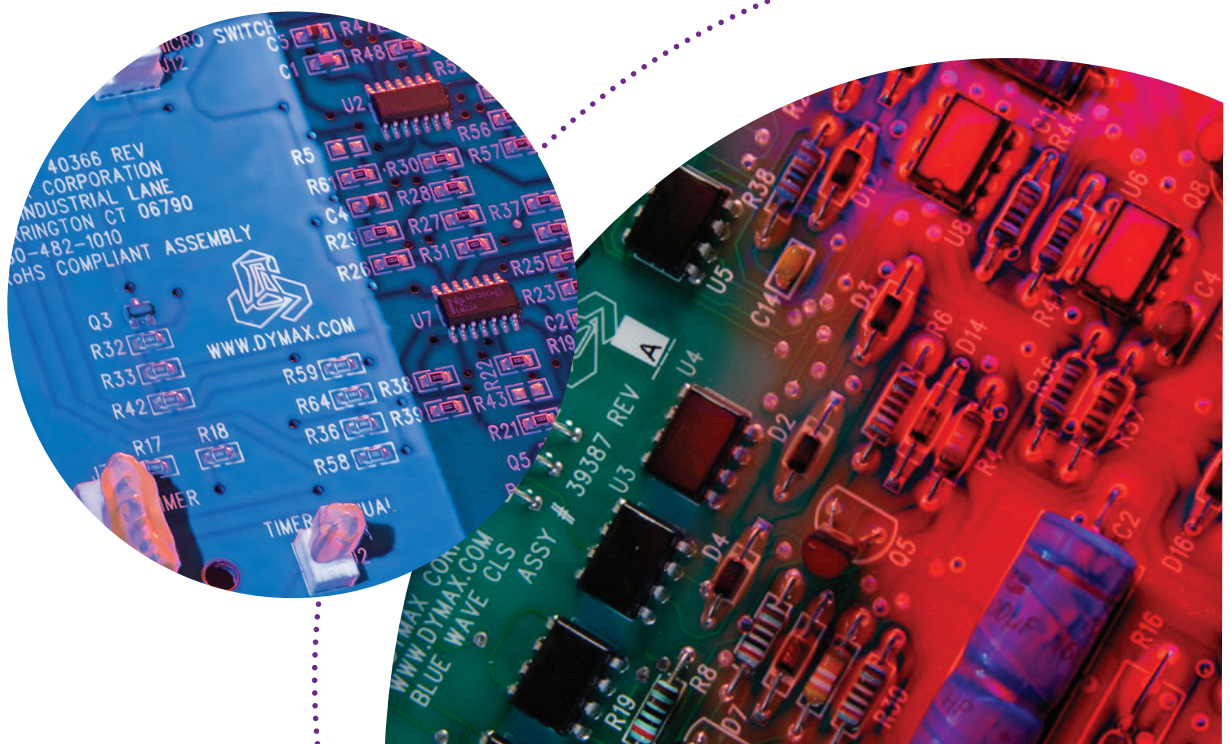

Dispensing Equipment

Dymax has developed high-quality, field-proven dispense systems to fit many types of adhesive and fluid dispensing applications. These systems include various automated and manual dispensing valves, spray valves and guns, controllers, material reservoirs, and related components for seamless integration into assembly processes. The systems provide accurate, consistent dispense for a range of low- to high-viscosity fluids. Dispensing systems with adjustable suck-back control and dispensing valves that offer contaminate-free dispensing are available.

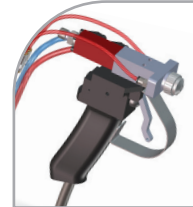
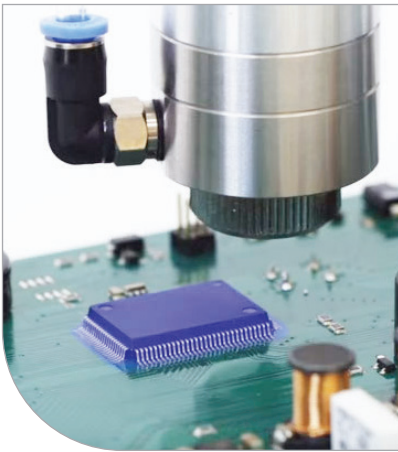

SD-100 Digital Syringe Dispenser

This dispensing system is ideal for use as an operator work station and can also be integrated into an automated process if needed. It provides an accurate way to dispense low-to-high viscosity materials from a syringe. The system is easy to set up and operate.

eco-PEN450 Dosing System

The eco-PEN 450 is ideally suited for dispensing very precise volumes of low- to medium-viscosity materials. It offers maximum volumetric precision for both dot and bead applications, making it an excellent choice for masking components on PCB boards or other small-area applications.

eco-SPRAY Precision Micro-Spray System

This micro-spray system is excellent for a wide range of applications and for use with a variety of low- to high-viscosity spray media. Users can achieve a variety of spray volumes, from dot to endless spraying.

SG-200 Super-Flow Spray Gun System

Dymax SG-200 super-flow spray gun systems are designed for masking and coating applications where a significantly higher flow rate is required. The systems are ideal for dispensing fluids with viscosities up to 80,000 cP. If you are manually masking a large area, this is a great option.

Model 400 Hand-Held Needle Valve System

The Model 400 needle valve is designed for dispensing very precise dots or fine beads of low- to medium-viscosity materials. The valve is hand-held but is compact and lightweight, making it easy and comfortable to handle.

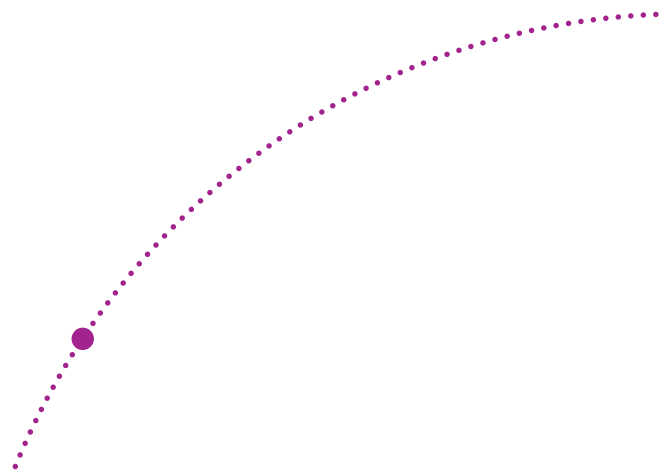

Light-Curing Systems

Dymax designs and manufactures a wide range of curing equipment including spot lamps, flood lamps, and conveyor systems, as well as radiometers and other accessories. Dymax systems are optimized to work with light-curable adhesives to gain process efficiencies by targeting rapid surface curing, depth of cure, and speed of cure, all while delivering light in a rapid and economical way. CE marked equipment is available.

Spot Lamps

Spot lamps provide a wide variety of methods to deliver light to a very precise location. They can be used manually by an operator or incorporated into a high-speed automated assembly line. Dymax offers multi-spectrum light-emitting lamps which use high-pressure mercury vapor bulbs, as well as light-emitting diode spot lamps, which use an array of surface-mounted LEDs instead of traditional metal halide or mercury bulbs.

Conveyor Systems

Conveyor systems consist of a moving belt that passes through a curing tunnel with multi-spectrum lamps mounted above or on each side for fast curing of parts. These conveyor systems are designed to offer consistent, fast, and safe curing. They can be outfitted with standard metal halide (longwave UV), mercury (shortwave UV), visible bulbs, or LED flood arrays. Consistent line speed, lamp height, and intensity provide a consistent light-curing process for high throughput.

Flood Lamps

Static flood-lamp systems are suited for area curing or for curing multiple assemblies. Dymax offers UV models which use moderate- to high-intensity, multi-spectrum UV/Visible light and LED models that use light-emitting diodes for fast curing. Dymax flood lamps can be easily integrated into existing manufacturing processes by mounting the lamps above high-speed assembly lines to achieve rapid cures. Shutter assemblies, mounting stands, and shields are available to create a custom curing system.

Radiometers

Measurement of the lamp intensity and dosage is critical to the successful implementation of light-curing technology. Dymax radiometers allow operators to monitor and document a light-curing process.

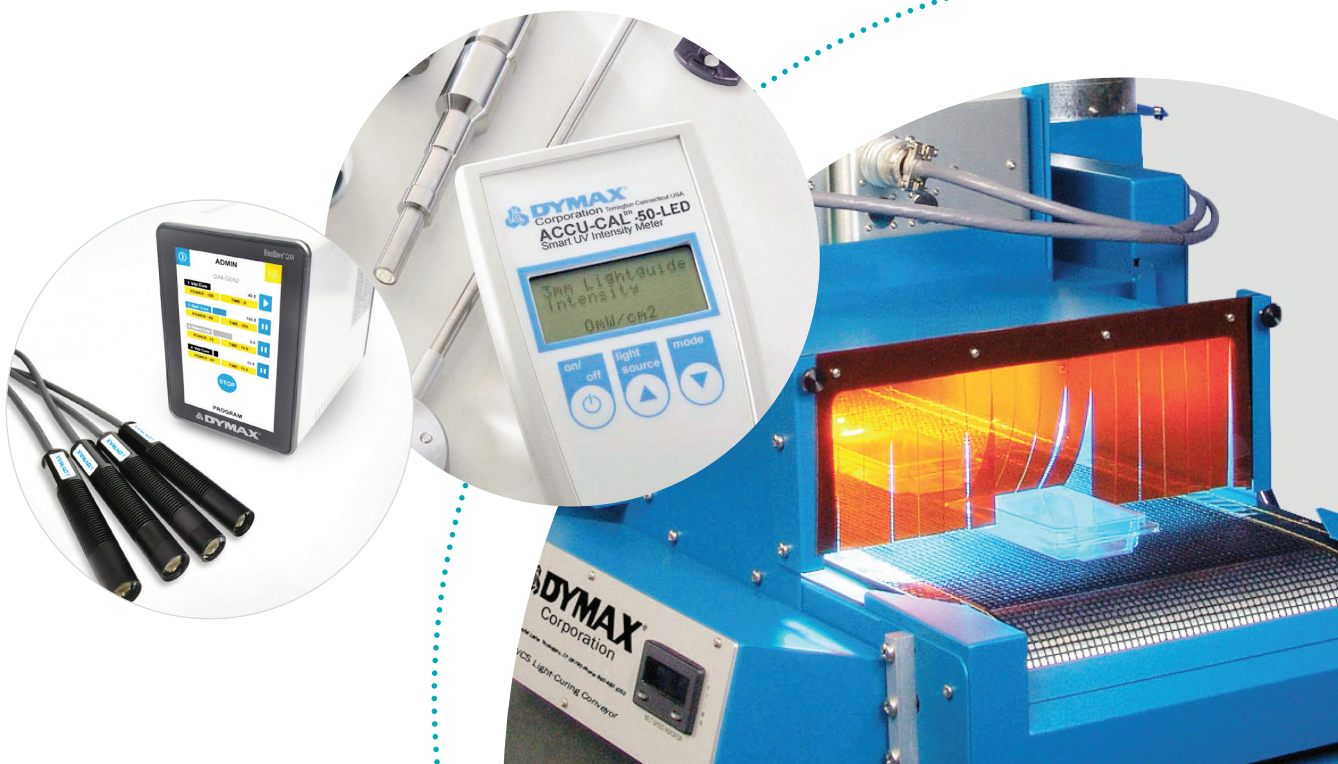



www.dymax.com

Americas

USA | +1.860.482.1010 | info@dymax.com

Europe

Germany | +49 611.962.7900 | info_de@dymax.com
Ireland | +353 21.237.3016 | info_ie@dymax.com

Asia

Singapore | +65.67522887 | info_ap@dymax.com
Shenzhen | +86.755.83485759 | info@hanarey.com
Hong Kong | +852.2460.7038 | dymaxasia@dymax.com
Korea | +82.31.608.3434 | info_kr@dymax.com

©2021-2022 Dymax Corporation. All rights reserved. All trademarks in this guide, except where noted, are the property of, or used under license by, Dymax Corporation, U.S.A.

Technical data provided is of a general nature and is based on laboratory test conditions. Dymax does not warrant the data contained in this bulletin. Any warranty applicable to the product, its application and use, is strictly limited to that contained in Dymax's standard Conditions of Sale. Dymax does not assume responsibility for test or performance results obtained by users. It is the user's responsibility to determine the suitability for the product application and purposes and the suitability for use in the user's intended manufacturing apparatus and methods. The user should adopt such precautions and use guidelines as may be reasonably advisable or necessary for the protection of property and persons. Nothing in this bulletin shall act as a representation that the product use or application will not infringe a patent owned by someone other than Dymax or act as a grant of license under any Dymax Corporation Patent. Dymax recommends that each user adequately test its proposed use and application before actual repetitive use, using the data contained in this bulletin as a general guide.

SG010DA 12/14/2022